

MioCARE⁺™

User Manual

MiCor A100

Wearable ECG Recorder

Table of Contents

- Important safety instructions2
- Overview.....7
 - Checking the package contents.....7
 - Getting to know your device8
 - Charging the battery9
- Getting started.....10
 - Activating the device10
 - Putting on the device10
 - Downloading the App.....11
 - Setting the date and time.....11
- Operating basics12
 - Changing the display mode12
 - Recording ECG data.....13
 - Connecting the device to your phone14
- Using the App.....15
 - Viewing ECG data15
 - Setting up the profile19
 - Device settings19
- For more information20
 - Support..... 20
 - Product Specifications.....20
 - IP2721
 - Safety precautions22
 - Caring for your device23
 - Federal Communication Commission Interference Statement.....24
 - Guidance and manufacturer’s declaration.....25

Important safety instructions

Symbols and markings

This appendix provides information about the symbols that are used on the product, its accessories or packing.



Follow instructions for use.



Type BF Applied Part - Electrically connected to patient.



Taiwan National Communications Commission (NCC) logo



Non-ionizing radiation



WEEE (Waste Electrical and Electronic Equipment). This product must not be disposed of as normal household waste, in accordance with the EU directive for waste electrical and electronic equipment (WEEE - 2002/96/EC). Instead, it should be disposed of by returning it to the point of sale, or to a municipal recycling collection point.

SN: WK0E6156789. The serial number of this device.

Model: N507. The model number of this device.

Cautions

- Caution! Federal law restricts this device to sale by or on the order of a physician.
- **CAUTION: MiCor A100 is MR-unsafe! Do not expose the device to a magnetic resonance (MR) environment. The device may present a risk of projectile injury due to the presence of ferromagnetic materials which can be attracted by the MR magnet core. Thermal injury and burns may occur due to the metal components of the device which can heat during MR scanning. The device may generate artifacts in the MR image. The device may not function properly due to the strong magnetic and radiofrequency fields generated by the MR scanner**

-
- Prolonged contact may contribute to skin irritation or allergies in some users. If you notice any signs of skin redness, swelling, itchiness, or other skin irritation, please discontinue. Continued use, even after symptoms subside, may result in renewed or increased irritation. If symptoms persist, consult your doctor.
 - The device contains electrical equipment that could cause injury if not handled properly.
 - Consult your doctor before beginning or modifying any exercise program.
 - Consult your doctor before use if you have any pre-existing conditions that might be affected by your use of this device.
 - Do not check call notifications or other data on the device's display while driving or in other situations where distractions could be hazardous.
 - This device is not a toy. Do not allow children or pets to play with your device. The device contains small components that can be choking hazard.
 - Please do not place the device in your bag or expose it to any external weight load, to avoid exceeding the limit of bearable weight of this device.
 - The device is with water ingress grade IP27. It is water proof under 1-meter depth of water but should not be worn while swimming and should not be submerged under water.
 - Please take off the device, clean and dry your device daily, particularly in areas in contact with the skin. Use a clean, damp cloth.
 - Clean it only with a soft cloth slightly dampened with warm water or a mild soap. Do not wash the device under a faucet.
 - Wear your device loosely enough to allow air circulation.
 - Use skin care products sparingly on the areas of the skin covered by your device.
 - Take the device off from time to time to clean it and allow for your skin to be uncovered.
 - Do not open the enclosure or disassemble your device.
 - Do not use your device if the display is cracked.

-
- Substances in this device and its battery may harm the environment or cause injury if handled and disposed of improperly.
 - Do not subject the device to excessive force, shock, dust, temperature changes, or humidity. Do not expose the unit to strong shocks or vibrations.
 - Do not place your device in a dishwasher, washing machine, or dryer.
 - Do not expose your device to extremely high or low temperatures.
 - Do not use your device in a sauna or steamroom.
 - Do not leave your device in direct sunlight for an extended period of time.
 - Do not dispose of your device in a fire. The battery could explode.
 - Do not use abrasive cleaners to clean your device.
 - Do not wear your device while charging it.
 - Do not charge your device while it is wet.
 - Disperse any static electricity from your body before using the unit. To avoid static electricity, use a small metal device (such as keys), cotton cloth, etc. to touch the door, doorknobs, faucets, chair, bet rails, etc. to eliminate static electricity, and then hand touch.
 - Remove your device if it feels warm or hot.
 - Due to printing limitations, the displays shown in this manual may differ from the actual display.
 - The contents of this user guide may not be reproduced without the permission of the manufacturer.

Warning on heart rate measurement

- Do not use with a defibrillator. Users do not apply to the use of regulator. 
- Do not use the unit in intensive care units or operating rooms.
- Do not operate the device near strong electrostatic field, otherwise the device could be

damaged by the electrostatic.

- Do not use in the presence of flammable anesthetics, drugs or pressurised oxygen (such as in a hyperbaric chamber, ultraviolet steriliser or oxygen tent).
- Do not take recordings in a location where the unit will be exposed to strong electromagnetic forces, such as near an arc welder, high-power radio transmitter, etc.
- Do not attempt self-diagnosis of the measurement results and analysis. Always consult the doctor.
- Do not take a recording if the electrodes are dirty. Clean them first.
- Do not use for any purpose other than obtaining physiological information.
- This device is not designed or intended for complete diagnosis of cardiac conditions. This device should never be used as a basis for starting or modifying treatment without independent confirmation by medical examination.
- When using this unit in hospitals or other medical facilities, use the unit under the supervision of your doctor.
- The heart rate is calculated by using the auto-correlation method to calculate the instant heart rate, and then get the average heart rate with all instant heart rates.
- If no beats are detected in the interval of 2 seconds, the interval is defined as "PAUSE."

Built-in battery precautions information

- Your device features a built-in battery, which is not user replaceable.
- Tampering with your device, or attempting to open it, will void the warranty and can result in a safety hazard. The main unit contains no user-serviceable parts.
- Contact the manufacturer's customer services if the device requires servicing.
- Use only the charger cable that shipped with your device to charge the battery.
- Charge the battery using a computer, powered hub, or power supply that is certified by a recognized testing laboratory.
- Charge the battery in accordance with the instructions supplied.

Disposal and recycling information

The symbol on the device or its packaging signifies that this device must be disposed of separately from ordinary household wastes at its end of life. Please kindly be aware that it is your responsibility to dispose of electronic equipment at recycling centres to help conserve natural resources.

For information about your recycling drop off point, please contact your local related electrical and electronic equipment waste management authority or the retailer where you bought the device.

- Do not dispose of your device with household waste.
- Disposal of the packaging and your device should be done in accordance with local regulations.
- Batteries are not to be disposed of in the municipal waste stream and require separate collection.

Intended Use

The device is intended for use by users who have transient symptoms that may suggest cardiac conduction abnormalities or by users who wants to monitor the cardiac function at home health care from Lead 1 ECG signal.

ECG acquisition and transmission is voluntary and mutually activated by the user. The intend users are adult.

The device is design to let user wear on wrist and record ECG signal while user feel transient cardiac abnormalities symptoms any time.

Users with implanted pacemaker are not recommended to use this device.

Overview

Thank you for purchasing a MioCARE product. This user manual guides you through the successful setup of your device and familiarises you with the basic skills of using the device.

The device is the wristband as wearable style. It is smaller and light weight, dry electrode and affordable ECG recording device. Its primary function is recording ECG signal of user/patient with one finger press on top of ECG plate of device. The device will record the user/patient ECG signal for 30 seconds and automatically store into build-in memory, meanwhile, the device also display the real time heart rate. The device can store 30 sets of ECG signal (30 seconds / set of data), then user can transfer ECG signal data from device to APP of the iPhone via BLE. The APP can display ECG of each recording ECG signal. And user can print the ECG and let his Cardiologist to refer and diagnose.

The device is build-in battery and for 15 days battery life and easy to know battery status as press button, user will have nice experience to wear this device without oppress.

Checking the package contents

Check the items contained in the package carefully. You should have the following:

- MiCor A100 Wearable ECG Recorder
- Magnet type USB charging cable
- Protection cover x 2
- *User manual*

Getting to know your device

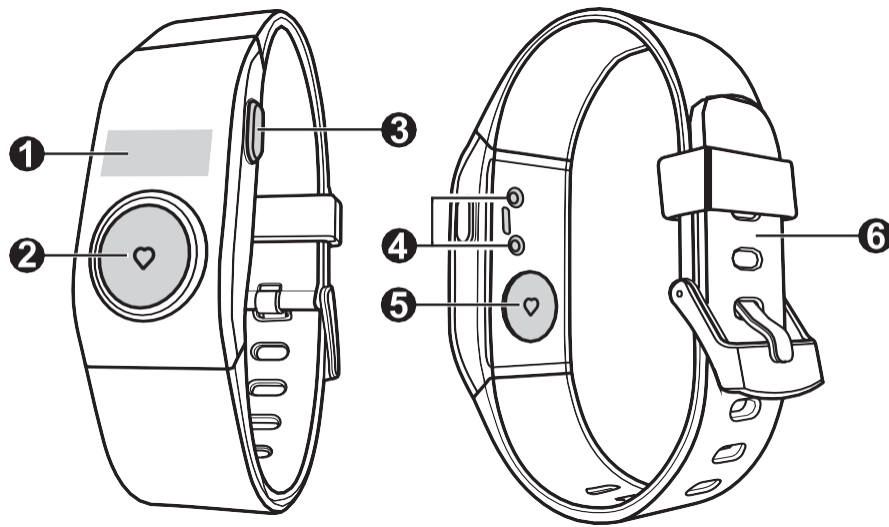

- ① OLED screen
- ② ECG sensor
- ③ MODE button

- ④ Charging connector
- ⑤ ECG sensor
- ⑥ Straps

Charging the battery

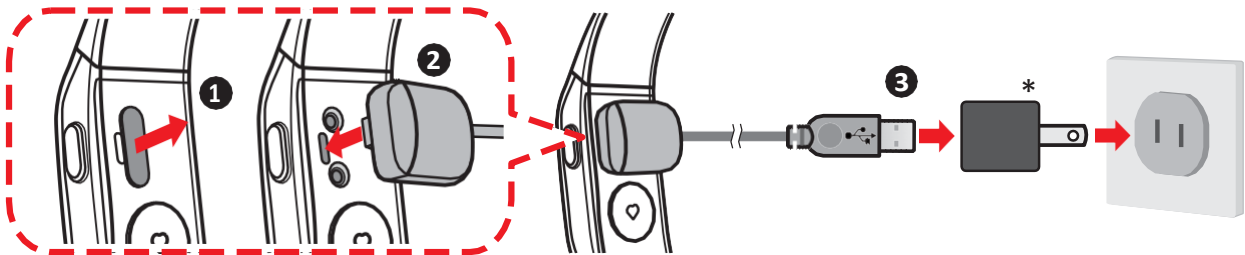

Your device has an internal battery that may not be fully charged when you purchase it. It is recommended to charge the battery for about 1 hour before you start using the device for the very first time. Follow the instructions below to charge the battery.

1. Remove the protection cover.
2. Connect the magnet type USB charging cable to the device's charging connector.
3. Connect the USB connector of the charger to the power supply*.



* The power supply accessories (not included) should be complied with IEC 60601-1 3.1.

NOTE: This device is intended to be supplied by a power unit that has output rated +5V dc/1.0A (maximum).

4. During charging, the Battery icon () on the screen indicates the battery charge status:
5. The  icon displays on the screen when the battery is fully charged. Remove the magnet type USB charging cable and then replace the protection cover.

Getting started

Activating the device

Once the device is connected to the power supply after unpacking, the system activates automatically.

Putting on the device

Putting on the device is like wearing a watch around your wrist. Follow the instructions below to wrap the straps around your wrist and then secure it with the buckle.

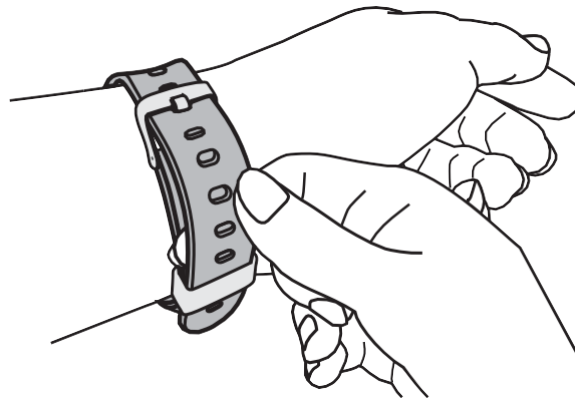

The device comes with a set of detachable straps that should be properly assembled before you use it. Follow the instructions below to detach/assemble the straps.

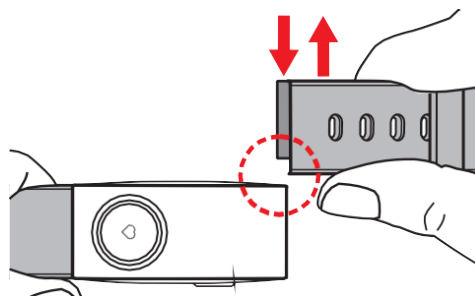

Downloading the App

MiCor A100 App is a free App on the Apple Store. After downloading and installing the App on your phone, you can use it to change the device's settings, view the detailed electrocardiogram, save and manage the ECG data and more functions via your phone.

NOTE: MiCor A100 App supports the mobile device running iOS 8.0.

Setting the date and time

To make sure that the date and time of your ECG recordings are correct, check the settings before you begin recording.

- Once the device is connected to your phone via the App, the date and time settings of the device will be automatically synchronised with the connected phone.
- You can set the displayed time format as 12-hour or 24-hour via the connected phone.

Operating basics

Changing the display mode

Press the MODE button repeatedly to cycle through the display modes: Time & date > ECG data amount > Battery status.

■ Time & date

Press the MODE button once to wake up the system and display the current time for 3 seconds and then the date for 2 seconds. The device will automatically enter Idle mode after 5 seconds of inactivity in time & date display mode.

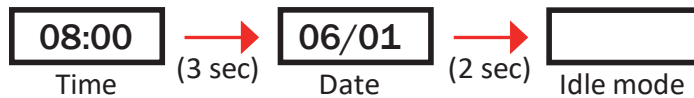

■ ECG data amount

Press the MODE button twice to display the amount of ECG data stored in the device. The device will automatically enter Idle mode after 5 seconds of inactivity in ECG data amount display mode.



NOTE: The  icon will display and flash on the screen while the ECG memory is full.

■ Battery status

Press the MODE button three times to display the battery status by the following icons. The device will display the FCC ID after 3 seconds of inactivity in battery status display mode, and then enter Idle mode.

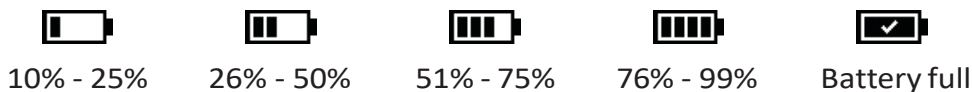

NOTE: The  icon will display and flash on the screen the battery power is less than 10%.

Recording ECG data

You can record and store up to 30 ECG data on the device. Follow the instructions to start recording ECG data.

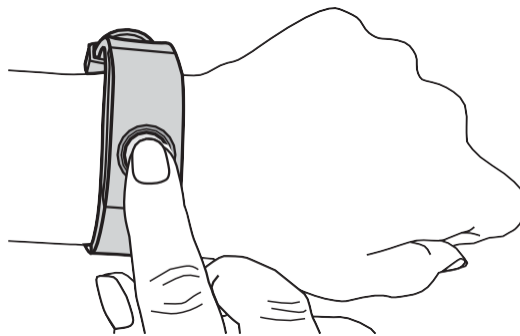

1. Wear the device on your wrist properly.
2. Press the MODE button to wake up the system from Idle mode.
3. Use your finger to touch the ECG sensor on the front panel for 2 seconds. After displaying the ECG data amount and vibrating once, the system enters ECG recording mode.
4. Wait for 3 seconds, and then the system will start recording ECG data.
Keep touching the ECG sensor for about 30 seconds and do not move until the recording is completed. You can check the recording status from the screen.
5. When done, the device will vibrate once and display the complete status on the screen.

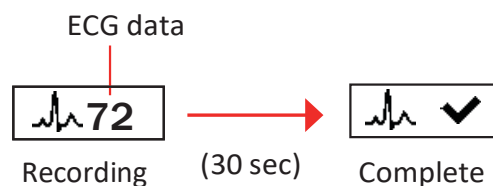

Now, you can connect the device to your phone and start synchronization. Once synchronized, the ECG data will be downloaded to your phone automatically.

NOTE: To obtain a correct ECG recording, please read the followings carefully and be sure that you observe the points each time you take a measurement.

- Make sure that the ECG sensors are directly touching your skin.
- If your finger and skin are dry, wipe them with a damp towel so that they are slightly moist.
- Keep the ECG sensors clean. You can clean the sensor parts by wiping them with a soft cloth or a cotton swab.
- Do not move during measurement. Any movement during measurement can affect the results.
- The ECG recording may be unreliable if the position of your finger is inappropriate during measurement.
- For some individuals measurement may not be possible. If you have problems during measurement, please contact your doctor for advice.

Connecting the device to your phone

Follow the instructions to connect the device to your phone via the App for the first time.

1. Download and install MiCor A100 App on your phone.
2. Make sure Bluetooth is activated and then launch the App.
3. Complete the initial settings including the profile and device settings.
 - Profile: Enter your name, birthday and gender in the fields.
 - Device settings: Select the time format.
4. Press the MODE button on the device so it will be discoverable for 5 seconds.
5. On you phone, select the device to pair and then enter the serial number (printed on the back panel of the device).
6. Once the pairing is completed, the data will be synchronised automatically.

Using the App

MiCor A100 App allows importing data from the device into your phone so that it can be examined and printed. This App features useful functions, such as changing of the scale and range of the ECG data, to better observe specific events which would be very helpful for doctor's reference.

NOTE: The screenshots and other presentations shown in the following sections may differ from the ones generated by the actual product.

Viewing ECG data

After launching and synchronising, you can read the recorded ECG data by selecting the item you wish to view from the ECG data list. The Details screen displays the detailed information of the ECG data.

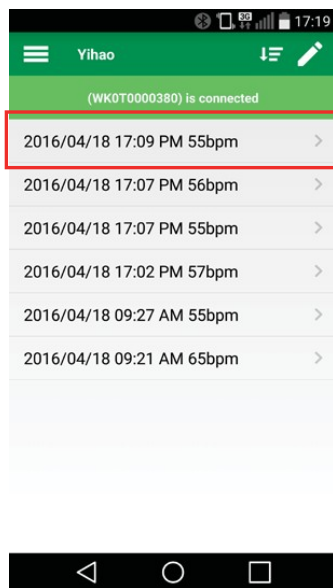

ECG data list



Details screen

The ECG data list

The ECG data list provides the general information including the User Name (as shown on the title bar) and recorded ECG data (sorted by date and time).

From the ECG data list, you can do one of the following:

- To delete the record, slide the item to the left and then tap **Delete**.

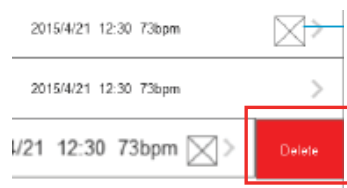

- Tap **Edit** to enter Edit mode, allowing you to:
 - Select the desired records by checking the buttons in front of the items.
 - Select all of the records by tapping **All**.
 - Delete the selected records (or all records) by tapping **Delete**.
- Tap **Menu** () to display the menu screen, allowing you to:
 - Select **Sync now** to start synchronization manually.
 - Select **Profile & Settings** to display the Profile & Settings screen.
 - Select **Add new user** to add a new user for the device.

The Details screen

The Details screen contains the detailed information of the ECG data, including the date/time, the ECG waveform and the Note field.

- The waveform area contains the ECG trace, the speed/gain and the average heart rate.
 - You can navigate the screen to view the 30-second ECG trace by dragging your fingertip horizontally across the screen.

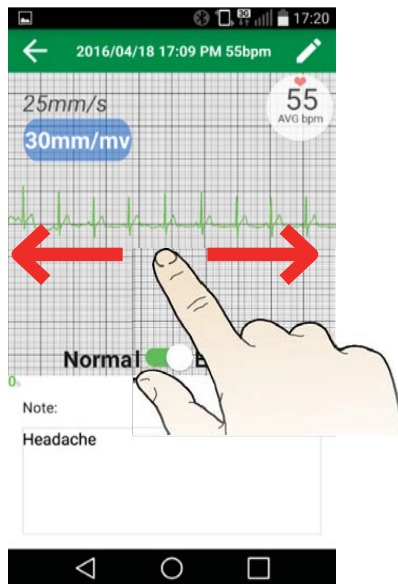

- While viewing the ECG trace, you can zoom in or out the waveform area by moving your fingertips apart or together on the screen.

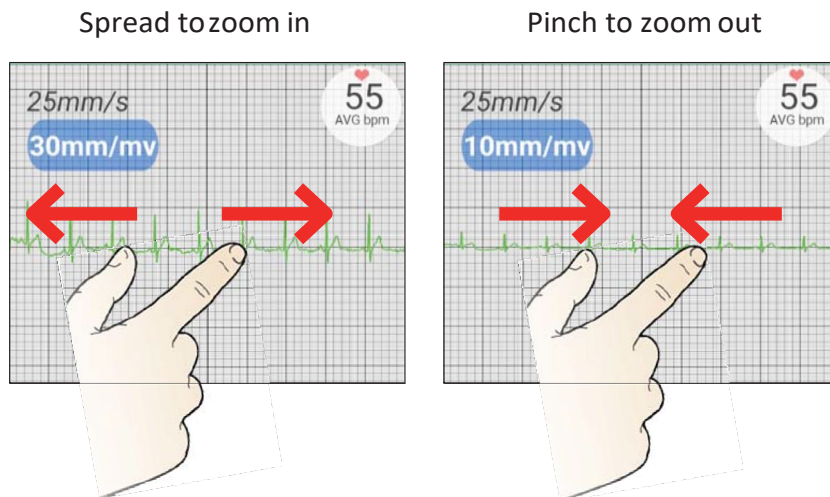

- Tap on the Note filed to take notes for the ECG data.
- Tap **Edit** to display the Edit list, allowing you to:

-
- Select **Email** to send the item by email.
 - Select **Print** to print it out.
 - Select **Delete** to delete the record.

Setting up the profile

Adding a user

The App is designed for multiple users that means, for example, you can use the same App to manage individual ECG data of the family members or multiple patients by a doctor.

1. From the ECG data list, tap **Menu** () to display the menu screen.
2. Select **Add new user**.
3. Repeat the process of setting up the Profile and Device Settings.
4. Connect the device.

Now, you can choose the desired user from the User list after launching the App.

Connecting the other devices

You can use the same App to manage the ECG data from different devices.

1. From the ECG data list, tap **Menu** () to display the menu screen.
2. Select **Profile & Settings**.
3. Tap **Device SN** to display the Device infoscreen.
4. Select **Change device** and then repeat the process of pairing a device.

Device settings

Setting the time format

You can set the displayed time format as 12-hour or 24-hour by disabling or enabling the **24 hour clock** option.

For more information

Support

For initial support, contact your doctor or your local authorized dealer. Please regularly check the website <https://autocloud.ibsalab.com/> for more information.

Manufacturer

MiTAC International Corp.

No. 200, Wen Hua 2nd Rd., Guishan Dist., Taoyuan City 33383, Taiwan (R.O.C.) Co-designed by PhysiolGuard Biotechnology Inc.



[U.S. \(Technical Support and Customer Service\)](#)

[21660 E. Copley Drive, Suite 170, Diamond Bar, CA 91765](#)

[Email: Tech.support@PhysiolGuard.com](mailto:Tech.support@PhysiolGuard.com)

[Tel: 1-909-394-5000](tel:1-909-394-5000)

Product Specifications

- Input impedance: > 10 M - Ohm
- Input dynamic range: +/- 200 mV
- Bandwidth: 0.1 - 40Hz
- CMRR (Common Mode Rejection Ratio): > 60dB
- A/D conversion: 16 bit
- Sampling rate: 250 samples/sec
- Measurement time: 30 seconds
- Display: 72 x 32 Dot - OLED
- Input: Dry conduction electrodes
- Output:
 - Bluetooth
 - IEEE 802.15 Bluetooth™ class II

-
- Operating range: < 7 m
 - Power supply: Non-replaceable internal Lithium Ion battery
 - Dimension: 45.6 x 21.4 x 11.3 mm (L x W xH)
 - Weight: 24.5g
 - Environmental conditions:
 - Storage temperature: -25°C - 70°C
 - Operating temperature: 5°C - 45°C; ECG plate: 46°C (Max.)
 - Humidity: 10% to 95%
 - Atmosphere pressure: 800 - 1013 hPa
 - Measurement range: Average heart rate 30 - 240bpm
 - Operating altitude: 2000m
 - Expected service life: 1 year
 - Charging clip:
 - Type: USB-port
 - Length: 20cm
 - Output Current: 500mA
 - Input Voltage: 5V
 - Output Interface: Pogo Pin

IP27

The IEC 60529/IP27 is a European system of test specification standards for classifying the degree of protection provided by the enclosures of electrical equipment. An IP27 designation means that the unit is protected against insertion of fingers, and which is protected from immersion between 15 centimeters and 1 meter in depth. The manufacturer guarantees this grade provided the battery door and all jack covers are properly and securely closed.

Safety precautions

About charging

- Use only the charger supplied with your device. Use of another type of charger may result in malfunction and/or danger.
- Use a specified battery in the equipment.

About the charger

- Do not use the charger in a high moisture environment. Never touch the charger when your hands or feet are wet.
- Allow adequate ventilation around the charger when using it to operate the device or charge the battery. Do not cover the charger with paper or other objects that will reduce cooling. Do not use the charger while it is inside a carrying case.
- Connect the charger to a proper power source. The voltage requirements are found on the product case and/or packaging.
- Do not use the charger if the cord becomes damaged.
- Do not attempt to service the unit. There are no serviceable parts inside. Replace the unit if it is damaged or exposed to excess moisture.

About the battery

CAUTION! This unit contains a non-replaceable internal Lithium Ion battery. The battery can burst or explode, releasing hazardous chemicals. To reduce the risk of fire or burns, do not disassemble, crush, puncture, or dispose of in fire or water.

- Use a specified battery in the equipment.
- Important instructions (for service personnel only)
 - Caution! Risk of explosion if battery is replaced by an incorrect type. Dispose of used batteries according to the instructions.
 - Replace only with the same or equivalent type recommended by the manufacturer.
 - The battery must be recycled or disposed of properly.
 - Use the battery only in the specified equipment.

Caring for your device

Taking good care of your device will ensure trouble-free operation and reduce the risk of damage.

- Keep your device away from excessive moisture and extreme temperatures (moisture > 95%, temperature > 60°C).
- Avoid exposing your device to direct sunlight or strong ultraviolet light for extended periods of time (> 48 hours).
- Do not place anything on top of your device or drop objects on your device.
- Do not drop your device or subject it to severe shock.
- Do not subject your device to sudden and severe temperature changes. This could cause moisture condensation inside the unit, which could damage your device. In the event of moisture condensation, allow the device to dry out completely before use.
- The screen surface can easily be scratched. Avoid touching it with sharp objects. Non-adhesive generic screen protectors designed specifically for use on portable devices with LCD panels may be used to help protect the screen from minor scratches.
- Never clean your device with it powered on. Use a soft, lint-free cloth to wipe the screen and the exterior of your device.
- Do not use paper towels to clean the screen.
- Never attempt to disassemble, repair or make any modifications to your device. Disassembly, modification or any attempt at repair could cause damage to your device and even bodily injury or property damage and will void any warranty.
- Do not store or carry flammable liquids, gases or explosive materials in the same compartment as your device, its parts or accessories.
- To discourage theft, do not leave the device and accessories in plain view in an unattended vehicle.

Federal Communication Commission Interference Statement

For regulatory identification purposes, your device is assigned a model number of N507.



FCC ID: P4Q-N507

This device complies with part 15 of the FCC Rules. Operation is subject to the following two conditions: (1) This device may not cause harmful interference, and (2) this device must accept any interference received, including interference that may cause undesired operation.

This device has been tested and found to comply with the limits for a Class B digital device, pursuant to Part 15 of the FCC Rules. These limits are designed to provide reasonable protection against harmful interference in a residential installation. This equipment generates, uses, and can radiate radio frequency energy, and, if not installed and used in accordance with the instructions, may cause harmful interference to radio communications. However, there is no guarantee that interference will not occur in a particular installation. If this equipment does cause harmful interference to radio or television reception, which can be determined by turning the equipment off and on, the user is encouraged to try to correct the interference by one or more of the following measures:

- Reorient or relocate the receiving antenna.
- Increase the separation between the equipment and receiver.
- Connect the equipment into an outlet on a circuit different from that to which the receiver is connected.
- Consult the dealer or an experienced radio/TV technician for help.

FCC Caution

Any changes or modifications not expressly approved by the party responsible for compliance could void the user's authority to operate the equipment.

The antenna(s) used for this transmitter must not be co-located or operating in conjunction with any other antenna or transmitter.

FCC RF Radiation Exposure Statement

This equipment complies with FCC radiation exposure limits set forth for an uncontrolled environment.

End users must follow the specific operating instructions for satisfying RF exposure compliance.

Guidance and manufacturer's declaration

Manufacturer's declaration-electromagnetic emissions		
The <u>N507</u> is intended for use in the electromagnetic environment (for home healthcare) specified below.		
The customer or the user of the <u>N507</u> should assure that it is used in such an environment.		
Emission test	Compliance	Electromagnetic environment-guidance (for home healthcare environment)
RF emissions CISPR 11	Group 1	The <u>N507</u> uses RF energy only for its internal function. Therefore, its RF emissions are very low and are not likely to cause any interference in nearby electronic equipment.
RF emissions CISPR 11	Class B	The <u>N507</u> is suitable for use in all establishments, including domestic establishments and those directly connected to the public low-voltage power supply network that supplies buildings used for domestic purposes.
Harmonic emissions IEC 61000-3-2	Class A	
Voltage fluctuations/ flicker emissions IEC 61000-3-3	Compliance	

Manufacturer's declaration-electromagnetic immunity

The N507 is intended for use in the electromagnetic environment (for home healthcare) specified below.

The customer or the user of the N507 should assure that it is used in such an environment.

Immunity test	IEC 60601 test level	Compliance level	Electromagnetic environment-guidance (for home healthcare environment)
Electrostatic discharge(ESD) IEC 61000-4-2	Contact:±8 kV Air±2 kV,±4 kV,±8 kV,±15 kV	Contact:±6 kV Air±2 kV,±4 kV,±8 kV	Floors should be wood, concrete or ceramic tile. If floors are covered with synthetic material, the relative humidity should be at least 30%
Electrical fast transient/burst IEC 61000-4-4	+ 2kV for power supply lines + 1kV for input/output lines	+ 2kV for power supply lines Not applicable	Mains power quality should be that of a typical home healthcare environment.
Surge IEC 61000-4-5	+ 0.5kV, +1kV line(s) to line(s) + 0.5kV, +1kV,+ 2kV line(s) to earth	+ 0.5kV, +1kV line(s) to line(s) Not applicable	Mains power quality should be that of a typical home healthcare environment.
Voltage Dips, short interruptions and voltage variations on power supply input lines IEC 61000-4-11	Voltage dips: 0 % UT; 0,5 cycle 0 % UT; 1 cycle 70 % UT; 25/30 cycles Voltage interruptions: 0 % UT; 250/300 cycle	Voltage dips: 0 % UT; 0,5 cycle 0 % UT; 1 cycle 70 % UT; 25/30 cycles Voltage interruptions: 0 % UT; 250/300 cycle	Mains power quality should be that of a typical home healthcare environment. If the user of the N507 requires continued operation during power mains interruptions, it is recommended that the N507 be powered from an uninterruptible power supply or a battery.

Power frequency(50, 60 Hz) magnetic field IEC 61000-4-8	30 A/m 50 Hz or 60 Hz	30 A/m 50 Hz, 60 Hz	The <u>N507</u> power frequency magnetic fields should be at levels characteristic of a typical location in a typical home healthcare environment.
NOTE: UT is the a.c. mains voltage prior to application of the test level.			

Manufacturer's declaration-electromagnetic immunity

The N507 is intended for use in the electromagnetic environment (for home healthcare) specified below.

The customer or the user of the N507 should assure that is used in such and environment.

Immunity test	IEC 60601 test level	Compliance level	Electromagnetic environment-guidance (for home healthcare environment)
<p>Conducted RF IEC 61000-4-6</p>	<p>3 Vrms: 0,15 MHz – 80 MHz</p> <p>6 Vrms: in ISM and amateur radio bands between 0,15 MHz and 80 MHz</p> <p>80 % AM at 1 kHz e)</p>	<p>3 Vrms: 0,15 MHz – 80 MHz</p> <p>6 Vrms: in ISM and amateur radio bands between 0,15 MHz and 80 MHz</p> <p>80 % AM at 1 kHz e)</p>	<p>Portable and mobile RF communications equipment should be used no closer to any part of the N507 including cables, than the recommended separation distance calculated from the equation applicable to the frequency of the transmitter.</p> <p>Recommended separation distance:</p> $d = 1,2 \sqrt{P}$ $d = 1,2 \sqrt{P} \quad 80 \text{ MHz to } 800 \text{ MHz}$ $d = 2,3 \sqrt{P} \quad 800 \text{ MHz to } 2,5 \text{ GHz}$ <p>Where P is the maximum output power rating of the transmitter in watts (W) according to the transmitter manufacturer and d is the recommended separation distance in metres (m).</p> <p>Field strengths from fixed RF transmitters, as determined by an electromagnetic site survey,^a should be less than the compliance level in each frequency range.^b</p> <p>Interference may occur in the vicinity of equipment marked with the following symbol:</p> 
<p>Radiated RF IEC 61000-4-3</p>	<p>10 V/m</p> <p>80 MHz – 2,7 GHz b)</p> <p>80 % AM at 1 kHz c)</p>	<p>10 V/m</p> <p>80 MHz – 2,7 GHz</p> <p>80 % AM at 1 kHz</p>	

NOTE 1: At 80 MHz and 800 MHz, the higher frequency range applies.

NOTE 2: These guidelines may not apply in all situations. Electromagnetic propagation is affected by absorption and reflection from structures, objects and people.

a. Field strengths from fixed transmitters, such as base stations for radio (cellular/cordless) telephones and land mobile radios, amateur radio, AM and FM radio broadcast and TV broadcast cannot be predicted theoretically with accuracy. To assess the electromagnetic environment due to fixed RF transmitters, an electromagnetic site survey should be considered. If the measured field strength in the location in which the N507 is used exceeds the applicable RF compliance level above, the N507 should be observed to verify normal operation. If abnormal performance is observed, additional measures may be necessary, such as re-orienting or relocating the N507.

b. Over the frequency range 150 kHz to 80 MHz, field strengths should be less than 3 V/m.

Recommended separation distance between portable and mobile RF communications equipment and the N507

The N507 is intended for use in an electromagnetic environment (for home healthcare) in which radiated RF disturbances are controlled. The customer or the user of the N507 can help prevent electromagnetic interference by maintaining a minimum distance between portable and mobile RF communications equipment (transmitters) and the N507 as recommended below, according to the maximum output power of the communications equipment.

Rated maximum output power of transmitter W	Separation distance according to frequency of transmitter m		
	150 kHz to 80 MHz $d = 1,2 \sqrt{P}$	80 MHz to 800 MHz $d = 1,2 \sqrt{P}$	800 MHz to 2,7 GHz $d = 2,3 \sqrt{P}$
0,01	N/A	0,12	0,23
0,1	N/A	0,38	0,73
1	N/A	1,2	2,3
10	N/A	3,8	7,3
100	N/A	12	23

For transmitters rated at a maximum output power not listed above, the recommended separation distance d in meters (m) can be estimated using the equation applicable to the frequency of the transmitter, where p is the maximum output power rating of the transmitter in watts (W) according to the transmitter manufacturer.

NOTE 1: At 80 MHz and 800 MHz, the separation distance for the higher frequency range applies.

NOTE 2: These guidelines may not apply in all situations. Electromagnetic propagation is affected by absorption and reflection from structures, objects and people.

Manufacturer's declaration-electromagnetic immunity

Test specifications for ENCLOSURE PORT IMMUNITY to RF wireless communications equipment

The N507 is intended for use in the electromagnetic environment (for home healthcare) specified below.

The customer or the user of the N507 should assure that it is used in such an environment.

Test frequency (MHz)	Band ^{a)} (MHz)	Service ^{a)}	Modulation ^{b)}	Maximum power (W)	Distance (m)	IMMUNITY TEST LEVEL (V/m)	Compliance LEVEL (V/m) (for home healthcare)
385	380 – 390	TETRA 400	Pulse modulation ^{b)} 18 Hz	1,8	0,3	27	27
450	430 – 470	GMRS 460, FRS 460	FM ^{c)} ±5 kHz deviation 1 kHz sine	2	0,3	28	28
710	704 – 787	LTE Band 13, 17	Pulse modulation ^{b)} 217 Hz	0,2	0,3	9	9
745							
780							
810	800 – 960	GSM 800/900, TETRA 800, iDEN 820, CDMA 850, LTE Band 5	Pulse modulation ^{b)} 18 Hz	2	0,3	28	28
870							
930							
1 720	1 700 – 1 990	GSM 1800; CDMA 1900; GSM 1900; DECT; LTE Band 1, 3, 4, 25; UMTS	Pulse modulation ^{b)} 217 Hz	2	0,3	28	28
1 845							
1 970							

2 450	2 400 – 2 570	Bluetooth, WLAN, 802.11 b/g/n, RFID 2450, LTE Band 7	Pulse modulation ^{b)} 217 Hz	2	0,3	28	28
5 240	5 100 – 5 800	WLAN 802.11 a/n	Pulse modulation ^{b)} 217 Hz	0,2	0,3	9	9
5 500							
5 785							

NOTE: If necessary to achieve the IMMUNITY TEST LEVEL, the distance between the transmitting antenna and the ME EQUIPMENT or ME SYSTEM may be reduced to 1 m. The 1 m test distance is permitted by IEC 61000-4-3.

- a) For some services, only the uplink frequencies are included.
- b) The carrier shall be modulated using a 50 % duty cycle square wave signal.
- c) As an alternative to FM modulation, 50 % pulse modulation at 18 Hz may be used because while it does not represent actual modulation, it would be worst case.

Disclaimer

Specifications and documents are subject to change without notice. The manufacturer does not warrant this document is error-free. The manufacturer assumes no liability for damage incurred directly or indirectly from errors, omissions, or discrepancies between the device and the documents.

Notes

Not all models are available in all regions.







Depending upon the specific model purchased, the colour and look of your device and accessories may not exactly match the graphics shown in this document.

The screenshots and other presentations shown in this document are for reference only. They may differ from the actual screens and presentations generated by the actual product.

Revision: R00 (5/2016) – [EUA \(04/23/2020\)](#)

13.1 Symbol

The symbols that are used on the product:

	Follow instructions for use
	Type BF Applied Part - Electrically connected to patient.
	Taiwan National Communications Commission (NCC) logo
	Non-ionizing radiation
	WEEE (Waste Electrical and Electronic Equipment). This product must not be disposed of as normal household waste, in accordance with the EU directive for waste electrical and electronic equipment (WEEE - 2002/96/EC). Instead, it should be disposed of by returning it to the point of sale, or to a municipal recycling collection point.
CE 0044	CE: CE Conformity Marking. 0044: Notified body identification numbers.
	Manufacturer